

PX50

Instructions for installation and use - English
Heat pump
Translation of the original instructions in French

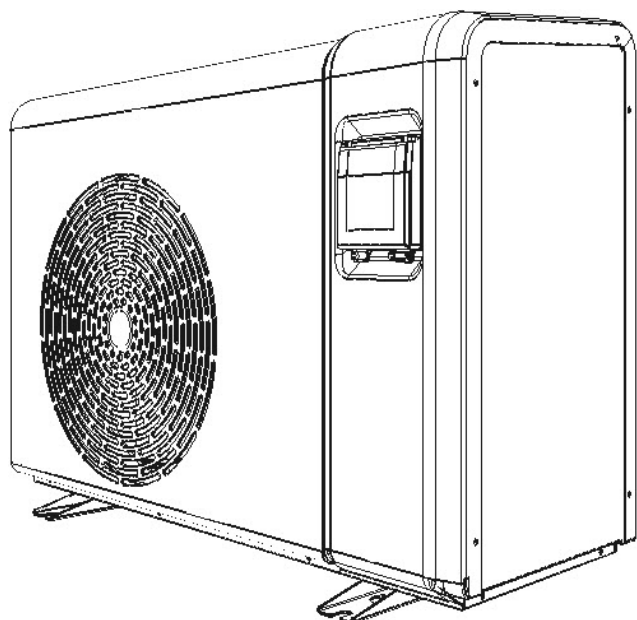



EN

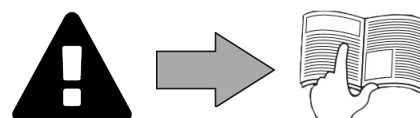



More documents on:
www.zodiac.com



WARNINGS

	This symbol shows that information is available such as the Operating Manual or Installation Manual.		This symbol shows that this appliance uses R32, a low burning velocity refrigerant.
	This symbol shows that the Operation Manual should be read carefully.		This symbol shows that service personnel should be handling this equipment with reference to the Installation Manual.

GENERAL WARNINGS

- Failure to respect the warnings may cause serious damage to the pool equipment or cause serious injury, even death.
- Only a person qualified in the technical fields concerned (electricity, hydraulics or refrigeration) is authorised to carry out maintenance or repair work on the appliance. The qualified technician working on the appliance must use/wear personal protective equipment (such as safety goggles and protective gloves, etc.) in order to reduce the risk of injury occurring when working on the appliance.  
- Before handling the appliance, check that it is switched off and isolated.
- The appliance is intended to be used for pools and spas for a specific purpose; it must not be used for any purpose other than that for which it was designed.
- This appliance is not intended for use by children.
- This appliance is not intended for use by individuals (including children, over the age of 8) lacking in experience or with impaired physical, sensory or mental capabilities, unless:
 - they receive supervision and are instructed on how to use the appliance by a person responsible for their safety; and
 - if they understand the hazards involved.
- Children must be supervised to ensure that they do not play with the appliance.
- The appliance must be installed according to the manufacturer's instructions and in compliance with local and national standards. The installer is responsible for installing the appliance and for compliance with national installation regulations. Under no circumstances may the manufacturer be held liable in the event of failure to comply with applicable local installation standards.
- For any work other than the simple user maintenance described in this manual, the product should be referred to a qualified professional.
- Incorrect installation and/or use may cause serious damage to property or serious injuries (possibly causing death).
- All equipment, even postage and packing paid, travels at the risks and perils of the recipient. The latter shall issue reserves in writing on the carrier's delivery slip if damage is detected, caused during transport (confirmation to be sent to the carrier within 48 hours by registered letter). In the event that an appliance containing refrigerant has been turned on its side, mention your reservations in writing to the carrier.
- If the appliance suffers a malfunction, do not try to repair it yourself; instead contact a qualified technician.
- Refer to the warranty conditions for details of the permitted water balance values

EN

for operating the appliance.

- Deactivating, eliminating or by-passing any of the safety mechanisms integrated into the appliance shall automatically void the warranty, in addition to the use of spare parts manufactured by unauthorised third-party manufacturers.
- Do not spray insecticide or any other chemical (flammable or non-flammable) in the direction of the appliance, as this may damage the body and cause a fire.
- Do not touch the fan or moving parts and do not place objects or your fingers in the vicinity of the moving parts when the appliance is in operation. Moving parts can cause serious injury or even death.

WARNINGS ASSOCIATED WITH ELECTRICAL APPLIANCES

- The power supply to the appliance must be protected by a dedicated 30 mA Residual Current Device (RCD), complying with the standards and regulations in force in the country in which it is installed.
- Do not use any extension lead when connecting the appliance; connect the appliance directly to a suitable power supply.
- If a fixed appliance is not equipped with a power cord and a plug, or any other means for disconnecting from the power supply network with contact separation in all poles allowing for complete disconnection in the event of category III overvoltage, the instructions shall specify that disconnection means must be integrated into the fixed wiring, in accordance with wiring rules.
- A suitable disconnection method, compliant with all local and national regulations on category III overvoltage, and which disconnects all poles of the power supply circuit, must be installed on the power supply circuit to the appliance. This disconnection method is not provided with the appliance and must be supplied by the professional fitter.
- Before carrying out any operations, check that:
 - The voltage indicated on the appliance information plate corresponds to the mains voltage.
 - The power grid must be adapted to the power requirements of the appliance, and is grounded.
 - The plug (where applicable) is suitable for the socket.
- In the event of abnormal operation or the release of odours from the appliance, turn it off immediately, unplug it from its power supply and contact a professional.
- Before servicing or performing maintenance on the appliance, check that it is powered off and completely disconnected from the power supply. Moreover, check that the heating priority (where applicable) is deactivated and that any other device or accessory connected to the appliance is also disconnected from the power supply.
- Do not disconnect and reconnect the appliance to the power supply when in operation.
- Do not pull on the power cord to disconnect it from the power supply.
- If the power cord is damaged, it must be replaced by the manufacturer, its technician or a qualified person to guarantee safety.
- Do not perform maintenance or servicing operations on the appliance with wet hands or if the appliance is wet.
- Before connecting the appliance to the power supply, check that the connection unit or socket to which the appliance will be connected is in good condition and

shows no signs of damage or rust.

- For any component or sub-assembly containing a battery: do not recharge or dismantle the battery, or throw it into a fire. Do not expose it to high temperatures or direct sunlight.
- In stormy weather, disconnect the appliance from the power supply to prevent it from suffering lightning damage.
- Do not immerse the appliance in water (with the exception of cleaners) or mud.

WARNINGS CONCERNING APPLIANCES CONTAINING REFRIGERANT

- R32 refrigerant is classed under category A2L as mildly flammable.
- Do not release R32 or R410A fluid into the atmosphere. These are fluorinated greenhouse gases, covered by the Kyoto Protocol, with a Global Warming Potential (GWP) of 675 for R32 and 2088 for R410A (European regulation EU 517/2014).
- The appliance must be stored in a well-ventilated location away from all ignition sources.
- Install the unit outdoors. Do not install the unit indoors or in an enclosed and non-ventilated outdoor location.
- Do not use means for accelerating the defrosting or cleaning process other than those recommended by the manufacturer.
- The appliance must be stored in a room without any permanent ignition source (such as open flames, operating gas appliance or operating electric heating).
- Do not perforate or incinerate.
- Please note that R32 refrigerant may give off a certain odour.
- In order to comply with the applicable standards and regulations in terms of the environment and installation, in particular French decree No. 2015-1790 and/or European regulation EU 517/2014, a leak test must be performed on the cooling circuit at least once a year. This operation must be carried out by a specialist certified to test cooling appliances.

INSTALLATION AND MAINTENANCE

- The appliance may not be installed close to combustible materials, or the air duct inlet of an adjacent building.
- With some appliances, it is essential to fit a "protection grid"-type accessory if the unit is installed in an area with uncontrolled access.
- During installation, troubleshooting and maintenance, pipes may not be used as steps: the pipe could break under the weight, spilling refrigerant and possibly causing serious burns.
- When servicing the appliance, the composition and state of the heat transfer fluid must be checked, as well as the absence of any traces of refrigerant.
- During the annual appliance sealing test in accordance with applicable legislation, the high and low pressure switches must be checked to ensure that they are securely fastened to the refrigerant circuit and that they cut off the electrical circuit when tripped.
- During maintenance work, ensure there are no traces of corrosion or oil around the cooling components.
- Before beginning work on the cooling circuit, stop the appliance and wait for a few minutes before fitting the temperature and pressure sensors. Some elements such as the compressor and piping may reach temperatures in excess of 100°C and high pressures with the consequent risk of severe burns.

MAINTENANCE: WARNINGS CONCERNING APPLIANCES CONTAINING R32 REFRIGERANT

Area check

- Before starting work on systems containing flammable refrigerants, safety checks must be carried out to guarantee a minimal ignition risk.

Work procedure

- The work must be carried out according to a controlled procedure in order to reduce the risks of releasing a flammable gas or vapour while working.

General work area

- All maintenance staff and other personnel working in the surrounding area must be made aware of the work carried out. Work conducted in enclosed areas must be avoided.

Check for the presence of refrigerant

- The area must be analysed using a suitable refrigerant detector before and during work so that the technician is informed of the presence of a potentially toxic or flammable atmosphere. Check that the leak detection equipment used is suitable for use with all refrigerants concerned, i.e. that it does not cause a spark, is correctly isolated or is entirely safe.

Check for the presence of a fire extinguisher

- If work must be carried out on the cooling equipment or any part associated therewith at a certain temperature, suitable fire extinguishing means must be within reach. Place a dry chemical fire extinguisher or CO₂ fire extinguisher near the work area.

No source of ignition

- No person carrying out work on a cooling system involving exposing the piping may use any ignition source, which could create a fire or explosion risk. All possible ignition sources, in particular cigarettes, must not enter within a sufficient perimeter of the installation, repair, removal or disposal site, in the event that refrigerant could be released into the surrounding space. Before starting the work, the area around the equipment must be examined to check for all fire or ignition risks. "No smoking" signs must be displayed.

Area ventilation

- Before accessing the unit in any manner whatsoever with the intention of performing any maintenance task, check that the area is open and well-ventilated. Suitable ventilation must be provided throughout the maintenance task to allow any refrigerant that could be released into the atmosphere to be safely dispersed.

Refrigeration equipment check

- The manufacturer's recommendations in terms of care and maintenance must always be complied with. When replacing electric components, check that components used are of the same type and category as those recommended/approved by the manufacturer. When in doubt, contact the manufacturer's technical department for assistance.
- The following checks must be applied to installations using flammable refrigerants:
 - if an indirect cooling circuit is used, the presence of refrigerant in the secondary circuit must be analysed;

- the markings on the equipment must remain visible and legible; any illegible markings or signs must be rectified;
- the hoses or components of the cooling circuit are installed in a position where they are unlikely to be exposed to any substance capable of corroding the components containing refrigerant, unless the components are made from materials that are typically corrosion-proof or correctly protected from such corrosion.

Electric component check

- The repair and maintenance of electric components must include initial safety checks and component inspection procedures. If a defect capable of jeopardising safety arises, no power supply must be connected to the circuit until the problem has been completely resolved. If the defect cannot be rectified immediately and if maintenance work must continue, an appropriate temporary solution must be found. This must be reported to the equipment's owner so that all persons concerned are made aware.
- The repair and maintenance of electric components must include the following initial safety checks:
 - the capacitors are discharged: this must be carried out safely to prevent all risks of ignition;
 - no electric component or live wiring is exposed while charging, overhauling or draining the system;
 - the system must be grounded at all times.

Repair of insulated components

- When repairing insulated components, all power sources must be disconnected from the equipment on which the work is being carried out before removing the insulating cover, etc. If the equipment must be powered during maintenance work, a leak detector must continuously monitor for leaks at the most critical point in order to report any potentially hazardous situation.
- Particular attention must be paid to the following points to ensure that, when performing work on the electric components, the housing is not altered to the point of affecting the protection rating. This includes damaged wires, an excessive number of connections, terminals that do not comply with the original specifications, damaged seals, incorrect installation of the cable glands, etc.
- Make sure that the appliance is properly fixed.
- Make sure that the seals or insulating materials are not deteriorated to the point that they no longer prevent a flammable atmosphere from penetrating the circuit. Spare parts must be compliant with the manufacturer's specifications.

Repair of intrinsically safe components

- Do not apply any permanent electric capacitance or induction charge to the circuit without checking that it does not exceed the allowed voltage and intensity for the equipment being used.
- Typically safe components are the only types on which work can be carried out in the presence of a flammable atmosphere when live. The test appliance must fall under a suitable classification.
- Only replace components with parts specified by the manufacturer. Other parts could cause the refrigerant to leak and ignite in the atmosphere.

Wiring

- Check that the wiring shows no signs of wear, corrosion, excessive pressure, vibration, cutting edges or any other detrimental environmental effect. The check must also take into account the effects of ageing or continuous vibrations caused by sources such as compressors or fans.

Detection of flammable refrigerant

- Under no circumstances must potential ignition sources be used to search for or detect refrigerant leaks. A halide torch (or any other detector using a naked flame) must not be used.
- The following leak detection methods are considered to be acceptable for all cooling systems.
- Electronic leak detectors can be used to detect refrigerant leaks; however, in the case of flammable refrigerants, the sensitivity level may not be suitable or recalibration may be necessary. (The detection equipment must be calibrated in an area devoid of refrigerant). Check that the detector is not a potential ignition source and is appropriate for the refrigerant used. The leak detection equipment must be adjusted to a percentage of the refrigerant's LFL and must be calibrated according to the refrigerant used. The appropriate gas percentage (25% at most) must be confirmed.
- Leak detection fluids are also suited for use with most refrigerants, however the use of detergents containing chlorine must be avoided since it could react with the refrigerant and cause corrosion to the copper piping.
- If a leak is suspected, all naked flames must be removed/extinguished.
- If a refrigerant leak is detected and requires soldering, the entire quantity of refrigerant must be removed from the system or isolated (by way of shut-off valves) in part of the system located away from the leak.

Removal and discharge

- When accessing the cooling circuit to carry out repairs, or for any other reason, conventional procedures must be employed. However, for flammable refrigerants, the recommendations must be complied with in order to take account of the product's flammability. The following procedure must be followed:
 - remove the refrigerant;
 - purge the circuit with an inert gas (optional for A2L);
 - drain (optional for A2L);
 - purge with an inert gas (optional for A2L);
 - open the circuit by cutting or soldering.
- The refrigerant charge must be recovered in suitable recovery cylinders. For appliances containing flammable refrigerants other than A2L refrigerants, the system must be bled with nitrogen devoid of oxygen to make the appliance suitable for receiving flammable refrigerants. You may need to repeat this process several times. Compressed air or oxygen must not be used to purge cooling systems.

Loading procedures

- Check that the vacuum pump outlet is not located in the vicinity of any potential ignition source and that ventilation is provided.
- In addition to conventional charging procedures, the following requirements apply.
 - Check that there is no possibility of cross-contamination between the different

refrigerants when using charging equipment. Hoses or lines must be as short as possible to reduce the quantity of refrigerant contained therein.

- Cylinders must be kept in an appropriate position, in accordance with the instructions.
- Check that the cooling system is grounded before charging the system with refrigerant.
- Label the system once charging is complete (if this is not already the case).
- Pay close attention to not overfilling the cooling system.
- Before recharging the system, carry out a pressure test using a suitable purge gas. The system must be examined to make sure there are no leaks after the charging operation and before commissioning. A follow-up leak test must be carried out before leaving the site.

Dismantling

- Before dismantling, the technician must familiarise himself/herself with the equipment and its specifications. We highly recommend carefully recovering all refrigerants. Before this, oil and refrigerant samples must be taken if analyses are to be carried out before any other use of the recovered refrigerant. Check for the presence of a power supply before starting work.
 1. Familiarise yourself with the equipment and how it operates.
 2. Electrically isolate the system.
 3. Before starting work, check the following points:
 - mechanical handling equipment is available if needed to handle the refrigerant cylinders;
 - all personal protective equipment is available and used correctly;
 - the recovery process is followed at all times by a cognizant person;
 - the recovery cylinders and equipment comply with the relevant standards.
 4. Drain the cooling system where possible.
 5. If a vacuum cannot be created, install a manifold in order to be able to remove the refrigerant from various locations within the system.
 6. Make sure that the cylinder is located on the scales before starting recovery operations.
 7. Start the recovery unit and operate as per its instructions.
 8. Do not overfill the cylinders (no more than 80% of the volume must be filled with liquid).
 9. Do not exceed the maximum working pressure of the cylinder, even temporarily.
 10. When the cylinders have been filled correctly and the process is complete, check that the cylinders and the equipment are quickly removed from the site and that the alternative shut-off valves on the equipment are closed.
 11. The recovered refrigerant must not be charged in another cooling system, unless it has been cleaned and inspected.

TROUBLESHOOTING

- All brazing must be carried out by qualified brazers.
- Replacement pipes must always be made of copper in compliance with standard NF EN 12735-1.
- Leak detection; pressure test:
 - never use oxygen or dry air, risk of fire or explosion,

- use dry nitrogen or the mixture of nitrogen and refrigerant indicated on the information plate,
- the test pressure for both the high and low pressure circuits must not exceed 42 bar in cases where the appliance is equipped with the optional pressure gauge.
- The high pressure circuit pipes are made of copper and have a diameter equal to or greater than 1"5/8. A certificate as indicated in §2.1 in compliance with standard NF EN 10204 must be requested from the supplier and filed in the installation's technical file.
- Technical data relative to the safety requirements of the various applicable directives are indicated on the information plate. All this information must be recorded in the appliance's installation manual, which must be kept in its technical file: model, code, serial number, maximum and minimum OT, OP, year of manufacture, CE marking, manufacturer's address, refrigerant and weight, electrical parameters, thermo-dynamic and acoustic performance.

LABELLING

- The equipment must be labelled so as to specify that it is out of order and that the refrigerant has been drained.
- The label must be dated and signed.
- For appliances containing a flammable refrigerant, check that labels are placed on the equipment stating that it contains a flammable refrigerant.

RECOVERY

- When draining the refrigerant for maintenance or decommissioning, best practices should be followed in order to safely drain all of the refrigerant.
- When transferring refrigerant to a cylinder, make sure that you use a recovery cylinder that is compatible with the refrigerant. Make sure that the correct number of cylinders are provided for recovering all of the refrigerant. All cylinders used must be intended for the recovery of refrigerant and must be labelled for this specific refrigerant. The cylinders must be equipped with a vacuum valve and a stop gate in good working order. Empty collection cylinders are drained and, where possible, cooled before recovery.
- The recovery equipment must be in good working order, the instructions for using the equipment must be within reach and the equipment must be compatible for use with the refrigerant concerned, including, where appropriate, a flammable refrigerant. Moreover, a set of calibrated scales must be available and in good working order. The pipework must be complete, have no leaks or disconnected connectors, and must be in good condition. Before using the recovery unit, check that it is in good working order, that it has been well maintained and that the associated electric components are sealed so as to prevent any risk of fire in the event of refrigerant being released. If you have any doubts, contact the manufacturer.
- The recovered refrigerant must be sent to the refrigerant supplier in its recovery cylinder with a waste transfer note. Do not mix different refrigerants in the recovery units, and in particular in the cylinders.
- If the compressor has been removed or if oil from the compressor has been drained, check that the refrigerant has been completely removed to prevent it from mixing with the lubricant. The draining process must be carried out before returning the compressor to the supplier. Only the electric heater of the compressor body can

be used to accelerate this process. This operation can be carried out safely once all liquids within the system have been drained.

EN

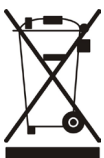

RECYCLING

This symbol means that your appliance must not be thrown into a normal bin. It will be selectively collected for the purpose of reuse, recycling or transformation. If it contains any substances that may be harmful to the environment, these will be eliminated or neutralised. Contact your retailer for recycling information.



- Before handling the appliance, it is vital that you read this installation and user manual, as well as the "Warranties" booklet delivered with the appliance. Failure to do so may result in material damage or serious or fatal injury and will void the warranty.
- Keep and pass on these documents for later viewing throughout the appliance's service life.
- The distribution or modification of this document in any way is prohibited, without prior authorisation from Zodiac®.
- Zodiac® is constantly developing its products to improve their quality. The information contained herein may therefore be modified without notice.

CONTENTS



1 Installation

11

1.1 | Selecting the location 11

1.2 | Hydraulic connections 12

1.3 | Accessing the electrical terminal blocks 13

1.4 | Power supply connections 13

1.5 | Option connections 14



2 Use

15

2.1 | Operating principle 15

2.2 | User interface presentation 15

2.3 | Operation 16

2.4 | User functions 17



3 Maintenance

19

3.1 | Winterising 19

3.2 | Servicing 19



4 Troubleshooting

20

4.1 | Appliance behaviour 20

4.2 | Error code display 21

4.3 | Wiring diagrams 25



5 Specifications

29

5.1 | Description 29

5.2 | Technical specifications 30

5.3 | Dimensions and marking 31



Tip: to make it easier to contact your retailer

- Write down your retailer's contact details to help you find them more easily and fill in the "product" information on the back of the manual; your retailer will ask you for this information.



1 Installation

1.1 I Selecting the location



- When the appliance is installed and protected by a residual current device (RCD) with a maximum amperage of 30 mA, it should be installed at a distance of at least 2 metres from the edge of the pool.
- If no RCD is installed with the appliance, it should be installed at a distance of at least 3.5 metres from the edge of the pool.
- Do not lift the appliance by the body; use its base.

- Installation is only permitted outdoors: provide for a clear space around the appliance as shown in the diagram under § "1.2 I Hydraulic connections".
- Place the appliance on its anti-vibration pads (supplied with the appliance, height adjustable) on a stable, solid and level surface,
- This surface must be able to bear the weight (see § "5.2 I Technical specifications") of the appliance (in particular in the case of installation on a roof, a balcony or any other support).

EN

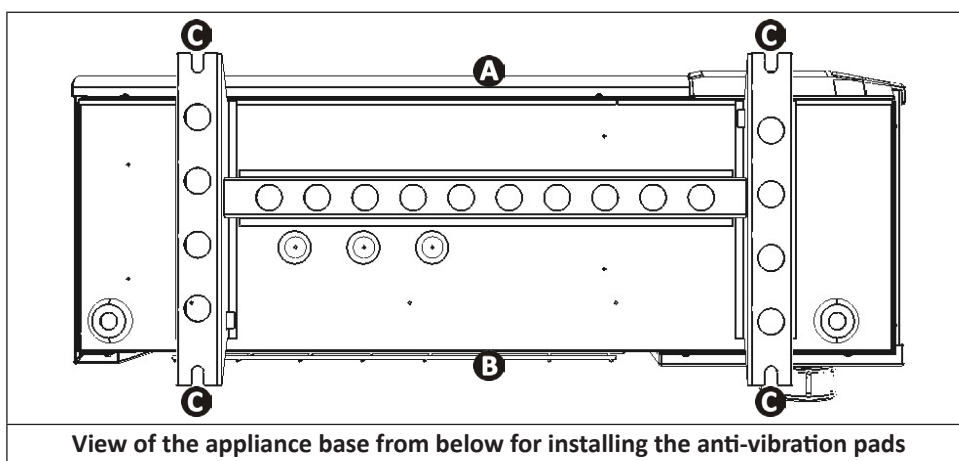

- **A**: Front
- **B**: Rear
- **C**: Anti-vibration pads

The appliance must not be installed:

- With the blowing towards any permanent or temporary obstacle less than 4 metres away,
- Within range of watering nozzles, sprays or water or mud run-off (take the effect of the wind into account),
- Near a heat source or flammable gas,
- Near high-frequency equipment,
- In a location where it would be subject to snow build-up,
- In a location where it might be flooded by the condensates produced by the appliance when operating.

Tip: to reduce noise produced by your heat pump



- Do not install it under or facing a window.
- Do not tilt it towards your neighbours.
- Install it in an open space (sound waves are reflected on surfaces).
- Install an acoustic screen around the heat pump, respecting the distances (see drawing § "1.2 I Hydraulic connections").
- Install 50 cm of flexible PVC pipe at the heat pump water inlet and outlet to absorb vibrations.

1.2 I Hydraulic connections

- The device will be connected with a $\varnothing 50$ PVC pipe, using the connectors supplied (see § “5.1 I Description”), to the pool's filtration circuit, after the filter and before the water treatment system.
- Respect the direction of hydraulic connection.
- A by-pass must be installed to make it easier to work on the appliance.

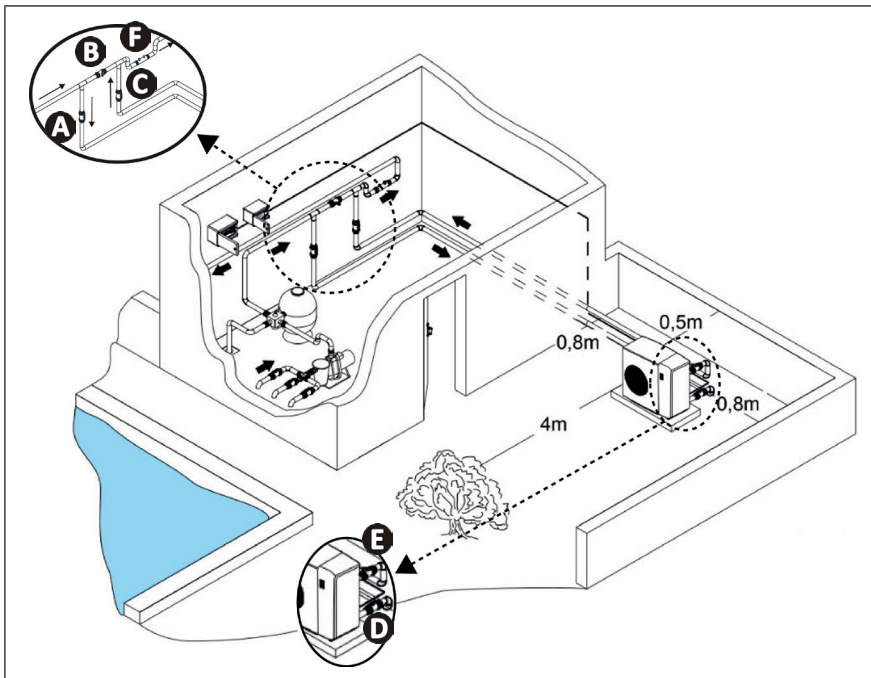

- A**: Water inlet valve
- B**: By-pass valve
- C**: Water outlet valve
- D**: Water inlet adjustment valve (optional)
- E**: Water outlet adjustment valve (optional)
- F**: Water treatment system

- To evacuate the condensates, fit an internal $\varnothing 18$ pipe under the appliance base.

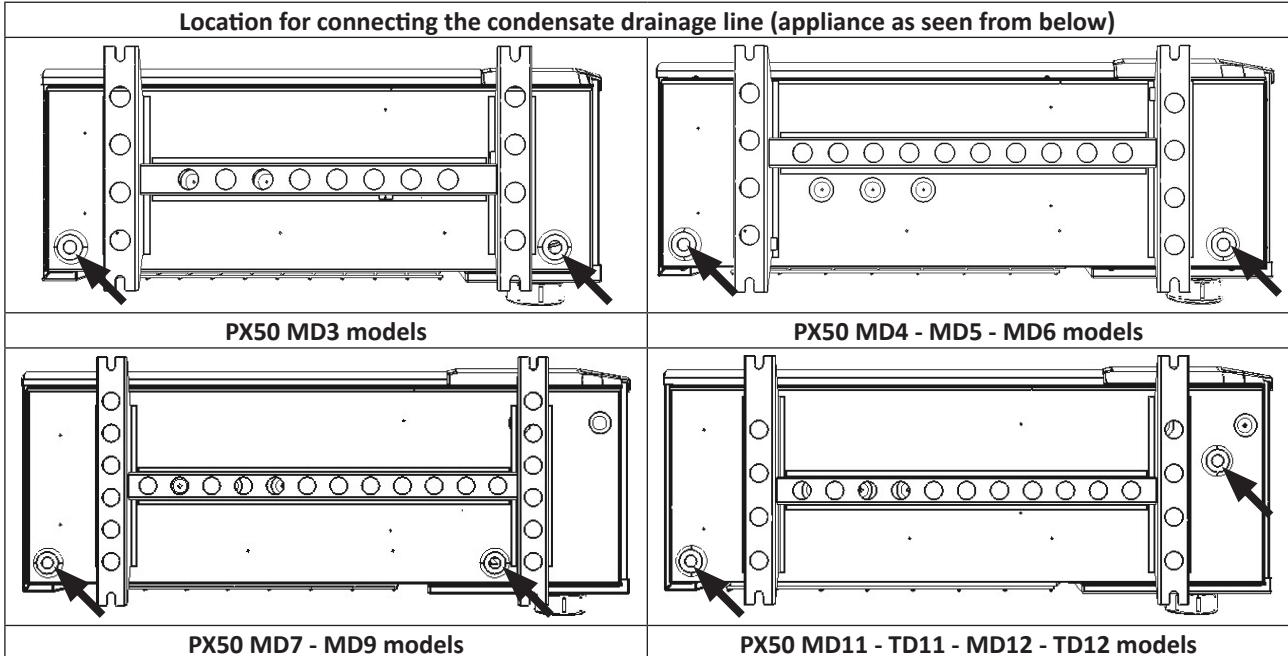

Tip: condensate drainage

Caution, several litres of water can be drained from your appliance each day. We strongly recommend connecting the drain to a suitable water drainage system.

➤ 1.3 I Accessing the electrical terminal blocks

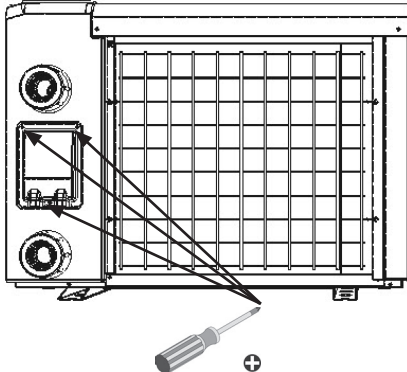
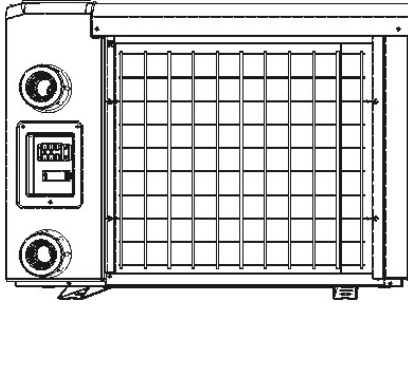
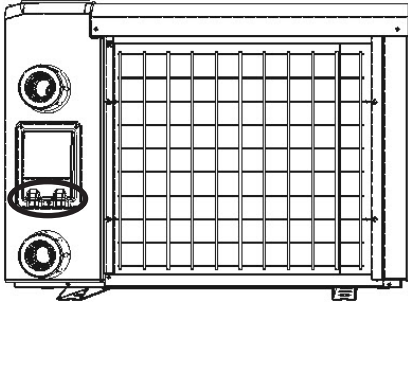
		
<p>Unscrew the 3 screws on the technical access door at the rear of the appliance.</p>	<p>Remove the technical access door.</p>	<p>Pass the cables through the cable glands on the technical access door.</p>

EN

➤ 1.4 I Power supply connections



- Before any work inside the appliance, you must cut the appliance's electricity supply as there is a risk of electric shock which may cause material damage, serious injury or even death.
- Incorrectly tightened terminals may cause the terminal box to heat up, which can invalidate the warranty.
- Only a qualified and experienced technician is authorised to carry out cabling work within the appliance or to replace the power cord.
- The installer must consult the electricity provider if necessary and ensure that the equipment is connected correctly to an electricity network with impedance under 0.095 ohm.

- The heat pump's electrical supply must be provided through a protection and circuit breaking device (not supplied) complying with the standards and regulations in force in the country where it is installed.
- The appliance is provided for connection to a general power supply with a TT or TN-S neutral regime.
- Electrical protection: by circuit breaker (D curve, rating to be defined according to the table in § "5.2 I Technical specifications"), with a suitable dedicated residual-current device (circuit breaker or switch).
- Additional protection may be required during installation to guarantee the overvoltage category II.
- The power supply must correspond to the voltage indicated on the appliance's information plate.
- The power cord must be insulated against any cutting or hot elements that may damage or crush it.
- The appliance must be connected to an earth socket.
- The electrical connection lines must be fixed.
- Use the gland to pass the power cord into the appliance.
- Use the power cord (RO2V type) adapted for outdoor or buried use (or run the cable into a protection duct) with an external diameter of between 9 and 18 mm.
- We recommend burying the cable at a depth of 50 cm (85 cm under a road or path) in an electrical duct (red ribbed).
- If this buried cable meets another cable or pipe (gas, water, etc.), there must be more than 20 cm between them.
- Connect the power cord to the terminal block inside the appliance.

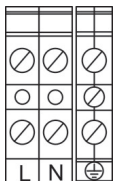
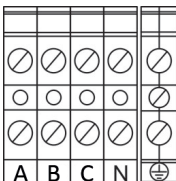
	<p>L: live N: neutral ⊕: earth</p>		<p>A/B/C: live N: neutral ⊕: earth</p>
<p>Terminal block for single-phase power</p>		<p>Terminal block for three-phase power</p>	

➤ 1.5 I Option connections

Connecting the "Heating priority" and "remote control" options:

- Before any work inside the appliance, you must cut the appliance's electricity supply as there is a risk of electric shock which may cause material damage, serious injury or even death.
- There is a risk of electrical return current, injuries, material damage and death when working on terminals 1 to 2.
- Any connection error with terminals 1 to 2 may damage the appliance and invalidate its warranty.
- Terminals 1 to 2 are dedicated to the options and must never be used to directly supply other equipment.
- Use cables with a section of at least $2 \times 0.75 \text{ mm}^2$, RO2V type and with a diameter between 8 and 13 mm.



Before connecting any options: remove the seal (above the cable gland) and install the cable gland provided in order to pass the cables into the appliance.

The cables used for the options and the power cord must be kept separate (risk of interference) using a collar inside the appliance just after the glands.

1.5.1 "Heating priority" option

- This function allows the appliance to start or maintain filtration (according to setting "P3") in order to detect the water temperature and thus activate the filtration + heating unit to maintain a constant water temperature. The filter pump is thus said to be slaved to the heating system. Filtration is kept in operation or activated if the pool temperature falls below the desired temperature.
- For the connection, connect the filtration timer to terminals 1 and 2 (dry contact, no polarity).

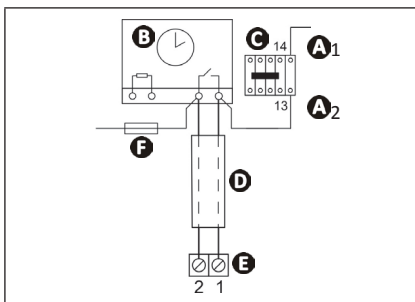

- **A1- A2:** Power for the filter pump power contactor coil
- **B:** Filtration timer
- **C:** Power contactor (three-pole or two-pole contactor) for the filter pump motor
- **D:** Separate cable for the "heating priority" function
- **E:** Heat pump terminal block
- **F:** Fuse

Information: «P3» setting

P3 = 0 «The filter pump starts and stops in line with the heat pump»

P3 = 1 «Filtering is constantly active»

		Water temperature < Setpoint temperature	Water temperature > Setpoint temperature
Timer OFF	P3 = 0	Filtration ON	Filtration OFF
	P3 = 1	Filtration ON	Filtration ON



- If «Timer» is active, the filtration pump starts and stops according to the programmed time periods and the configuration of the «P3» setting.

			Water temperature < Setpoint temperature	Water temperature > Setpoint temperature
Timer ON	P3 = 0	Operating times ON	Filtration ON	Filtration OFF
		Operating times OFF	Filtration OFF	Filtration OFF
	P3 = 1	Operating times ON	Filtration ON	Filtration ON
		Operating times OFF	Filtration OFF	Filtration OFF

1.5.2 "Remote control" option

- This option enables the appliance's user interface to be transferred in order to control the appliance remotely. To do so, use the remote control kit.
- To connect the kit, connect the signal wire to the pins on the controller.
- Pass the wire through the connection block.
- Then connect the connector to the printed circuit board.



2 Use

2.1 | Operating principle

2.1.1 General operation

Your heat pump uses the calories (heat) in the air to heat up your pool's water. The process to heat your pool's water to the temperature you want may take a few days as it depends on the weather conditions, the heat pump's power and the difference between the water temperature and the temperature you want.

The hotter and more humid the air, the better your heat pump will perform. The outdoor parameters for optimal operation are an air temperature of 27°C, a water temperature of 27°C and 80% relative humidity.



Tip: to improve the heating and maintaining of your pool's temperature

- Anticipate the commissioning of your pool far enough in advance before you use it.
- When heating, set the water circulation to continuous operation (24/7).
- To maintain the temperature throughout the season, run "automatic" circulation for the equivalent of the water temperature divided by two (the longer this time, the more sufficient the operating range of the heat pump to heat the pool).
- Cover the pool with a sheet (bubble canopy, canvas, etc.) to prevent heat loss.
- The heat pump will be even more efficient if it operates during the warmest hours of the day.
- Keep the evaporator clean.
- Set the temperature you want and let the heat pump run (adjusting the setpoint to maximum will not heat the water more quickly).
- Connect the "Heating priority"; the filter pump and heat pump's operating time will be set according to requirements.

EN

2.2 | User interface presentation

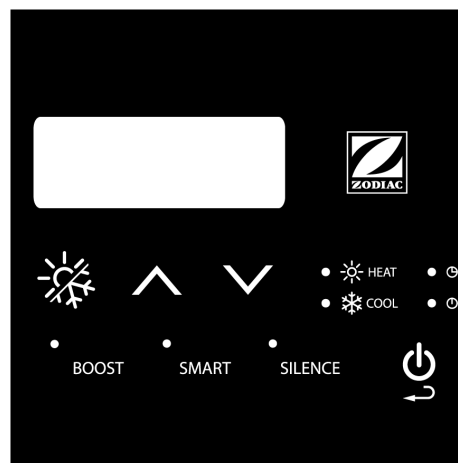

	Function	
Keys		"On/off" or "back/exit"
		To browse and adjust the values
		To select the operating mode: "HEATING", "COOLING" or "HEATING & COOLING" (automatic control)
	BOOST	To select "BOOST" mode
	SMART	To select "SMART" mode (default setting)
	SILENCE	To select "SILENCE" mode

	Description	Steady	Flashing	Off	
Indicator lights	● ☀ HEAT	"HEATING" mode	Operating in "HEATING" mode	/	Disabled
	● ❄ COOL	"COOLING" mode	Operating in "COOLING" mode	/	Disabled
	● ☀ HEAT ● ❄ COOL	"HEATING & COOLING" mode	Operating in "HEATING & COOLING" mode	/	Disabled
	● BOOST	"BOOST" mode	"BOOST" mode activated	Operating at full power in "SMART" mode	Disabled
	● SMART	"SMART" mode	"SMART" mode activated	Operating at medium power in "SILENCE" mode	Disabled
	● SILENCE	"SILENCE" mode	"SILENCE" mode activated	/	Disabled
	🔔	Alarm	Alarm enabled	/	Disabled
	🔒	Padlock	Keypad locked	/	Disabled
	● ⌚	"TIMER" ON	Configuration in progress	/	Disabled
	● ⏸	"TIMER" OFF	Configuration in progress	/	Disabled
	°C / °F	Celsius/Fahrenheit	Selected temperature unit	/	Disabled

➤ 2.3 I Operation

- Check that there are no tools or other foreign objects in the machine,
- Refit the panel providing access to the technical part (see § "5.3 I Dimensions and marking"),
- Set the valves as follows: valve B wide open, valves A, C, D and E closed.

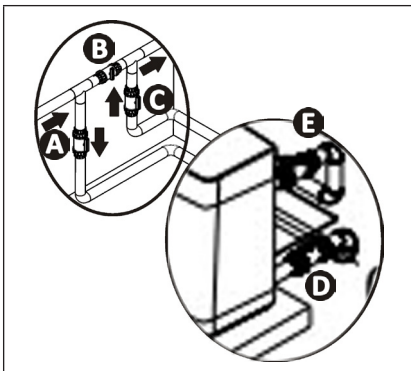

- A**: Water inlet valve
- B**: By-pass valve
- C**: Water outlet valve
- D**: Water inlet adjustment valve (optional)
- E**: Water outlet adjustment valve (optional)



- **An incorrect by-pass setting may cause the heat pump to malfunction.**

- Check that the hydraulic connections are correctly tightened and that there are no leaks.
- Check that the appliance is stable.
- Turn on the water flow (by activating filtration).
- Close valve B gradually so that the filter pressure is increased by 150g (0.150 bars).
- Open valves A, C and D fully then valve E by half (the air which has built up in the heat pump condenser and the filtration circuit will bleed out). If valves D and E are not present, open valve A wide and close valve C by half.
- Connect the power supply to the heat pump.
- The heat pump is on standby.
- Press .
- Set the desired temperature (called the "temperature setpoint") (see § "2.4.2 Changing operating mode").

After the start-up steps for your heat pump:



- Shut down the water circulation temporarily (by stopping the filtration or closing valve B or C) to check that your appliance stops after a few seconds (via the activation of the flow switch).
- Reduce the temperature setpoint to below the water temperature to check that the heat pump stops operating.
- Switch off the heat pump by pressing  and check that it stops.

➔ 2.4 | User functions

2.4.1 "Automatic keypad lock" function

The "automatic keypad lock" function allows the keypad to be disabled when inactive for a certain period of time to prevent mishandling.

Locking/unlocking the keypad:

- Press  +  simultaneously for 5 seconds.
The  indicator appears (= locked) or disappears (= unlocked) depending on the keypad's state.

2.4.2 Changing operating mode

The PX50 heat pump can operate in "HEATING", "COOLING" or "HEATING & COOLING" (automatic regulation) mode.

Information: "HEATING" mode

- When "HEATING" mode is selected, the PX50 heat pump heats the pool water to the temperature setpoint.
- The heat pump stops automatically once the temperature setpoint is reached.

Information: "COOLING" mode

- When "COOLING" mode is selected, the PX50 heat pump cools the pool water to the temperature setpoint.
- The heat pump stops automatically once the temperature setpoint is reached.





Information: "HEATING & COOLING" mode (automatic regulation)

- When the "HEATING & COOLING" operating mode is selected, the PX50 heat pump automatically switches to "HEATING" mode (if the water temperature falls $\leq -1^{\circ}\text{C}$ below the temperature setpoint) or to "COOLING" mode (if the water temperature rises $\geq +2^{\circ}\text{C}$ above the temperature setpoint) in order to maintain the pool at the temperature setpoint.





Example: When the temperature setpoint is 28°C , if the water temperature rises to 30°C , the heat pump will automatically switch to "COOLING" mode to return to the temperature setpoint. If the water temperature falls to 27°C , the heat pump will automatically switch to "HEATING" mode to return to the temperature setpoint.

To switch to "HEATING", "COOLING" or "HEATING & COOLING" (automatic control) mode:

- Press  for 5 seconds to select "HEATING", "COOLING" or "HEATING & COOLING" (automatic regulation) mode.
The corresponding indicator lights up to indicate the mode selected.
In "HEATING & COOLING" mode (automatic regulation), the 2 indicators •  HEAT and •  COOL are lit.

2.4.3 Configuring the temperature setpoint

Begin by selecting the desired operating mode: "HEATING", "COOLING" or "HEATING & COOLING" (automatic regulation) using the  key.

- Press  or , the setpoint value of the previously selected operating mode will flash.
- Press  to increase the temperature by 0.5°C ,
- Press  to reduce the temperature by 0.5°C .
- Press  to confirm and exit "configuration" mode.

2.4.4 "BOOST", "SMART" and "SILENCE" mode

The PX50 heat pump can adapt its power to suit the pool temperature and weather conditions. In doing so, it obtains maximal energy efficiency at a very low noise level.

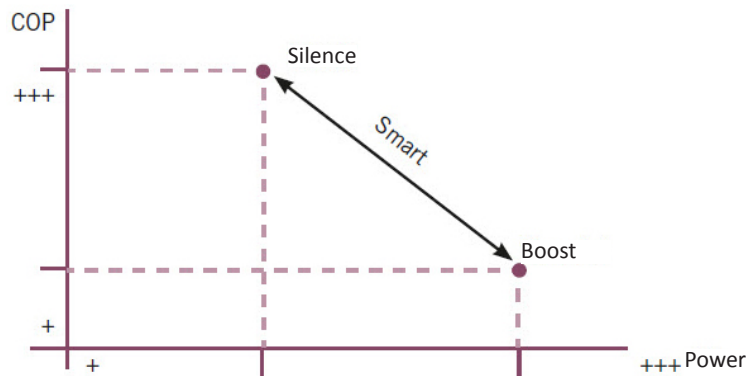

		"BOOST" mode	"SMART" mode	"SILENCE" mode
Compressor operating speed*	HIGH	● BOOST	● SMART	● SILENCE
	MID			
	LOW			
Operating principle		The heat pump operates at full power.	The heat pump operates intelligently, at medium to high speeds.	The heat pump operates at low power for lower consumption and less noise.
			Adapts the power automatically to requirements.	
When to use		Heating: when commissioning the pool.	To maintain the temperature	
		Cooling: hot zones, heat waves, sheltered pools, etc.	When you don't want to handle the appliance	Low heating requirements and silent operation desired

* The compressor speed directly affects the appliance's power output.

- Press **BOOST**, **SMART** or **SILENCE** the indicator above the selected mode is lit.

Information: "SMART" mode

- When the heat pump is operating at full power in "SMART" mode, the "SMART" indicator light is lit and the "BOOST" indicator light flashes.

Information: "SILENCE" mode

- When the heat pump is operating at medium power in "SILENCE" mode, the "SILENCE" indicator light is lit and the "SMART" indicator light flashes.

2.4.4 Configuring the "TIMER"

- Press then to view the "timer activation" ("P2"), "on time" ("P5") and "off time" ("P6") settings for the "TIMER".

Settings	Meaning	Amplitude	Default setting	Comments
P2	Timer activation	0 - 1	0	0 = timer disabled 1 = timer enabled
P5	On time	HH:MM	00:00	0-23:0-59
P6	Off time	HH:MM	00:00	0-23:0-59



3 Maintenance

3.1 I Winterising



- Even though the appliance can be used year round, if it will not be used for the winter months, a suitable winterising procedure must be implemented to prevent damage to the condenser. Damage caused by improper winterising of the appliance when not in use is not covered by the warranty.
- To prevent condensation from damaging the appliance: cover the appliance with the winterising cover supplied (do not hermetically-seal the appliance inside a cover).

- Set the regulator to "standby" mode by pressing  and disconnect the power supply,
- Open valve B (see § "1.2 I Hydraulic connections"),
- Close valves A and C and open valves D and E (if present, see § "1.2 I Hydraulic connections"),
- Make sure that there is no water circulating in the heat pump,
- Drain the water from the condenser (risk of freezing) by unscrewing the two water inlet and outlet connectors on the back of the heat pump,
- In the case of full winterising for the pool (complete shutdown of the filtration system, bleed the filtration circuit or even pool drainage): re-fit the two connectors by one turn to prevent any foreign bodies from getting into the condenser,
- In the case of winterising the heat pump only (shutdown of the heating only, the filtration keeps running): do not re-fit the connectors; instead add 2 caps (not provided) on the condenser's water inlet and outlet.
- We recommend that you put the aired winterising micro cover (provided) over the heat pump.

EN

3.2 I Maintenance



- Before any maintenance work on the appliance, you must cut the electricity supply as there is a risk of electric shock which may cause material damage, serious injury or even death.
- It is recommended that the appliance undergo general servicing at least on a yearly basis to ensure its proper operation, maintain performance levels and prevent any possible failures. These operations are carried out at the user's expense, by a qualified technician.

3.2.1 User maintenance

- Make sure that the ventilation grid is not blocked by any foreign bodies.
- Clean the evaporator (for location see § "5.3 I Dimensions and marking") using a soft brush and a fresh water spray (disconnect the power cable); do not fold over the metal wings, then clean the condensate drainage line to remove any impurities that may be blocking it.
- Do not use a high pressure jet. Do not spray with rain water, salt water or water which is full of minerals.
- Clean the outside of the appliance using a solvent-free product; a specific "PAC NET" cleaning kit is available as an accessory in the Zodiac® catalogue for this purpose (see § "5.1 I Description").

3.2.2 Maintenance to be carried out by a qualified technician



- Please read the safety instructions provided in the chapter entitled "Maintenance: warnings concerning appliances containing R32 refrigerant" (pages 4 to 8) before performing any of the maintenance operations described below.

- Check that the control system is operating correctly.
- Check that the condensates flow correctly when the appliance is in operation.
- Check the safety mechanisms.
- Check the connection of the metal masses to the earth.
- Check that the electrical cables are correctly tightened and connected and that the switch box is clean.



4 Troubleshooting













































- If a problem occurs, before you contact your retailer, please carry out these few simple checks using the following tables.
- If the problem continues, contact your retailer.
- : Actions to be performed by a qualified technician only



















4.1 I Appliance behaviour







The appliance does not start heating straight away	<ul style="list-style-type: none"> • When the setpoint temperature is reached, the heat pump stops heating: the water temperature is higher than or equal to the setpoint temperature. • When the water flow rate is zero or is not enough, the heat pump stops: check that the water is circulating correctly in the heat pump (see § "2.2 I User interface presentation") and that the hydraulic connections are correct. • The outdoor temperature is outside the heat pump's operating range. • It may be that the heat pump has detected an operating fault (see § "4.2 I Error code display"). • If you have checked these points and the problem persists: contact your retailer.
The appliance is discharging water	<ul style="list-style-type: none"> • Often called condensates, this water is the moisture contained in the air which condenses on contact with certain cold mechanisms in the heat pump, especially on the evaporator. The damper the air, the more condensates your heat pump will produce (your appliance may drain several litres of water per day). This water is recovered at the base of the heat pump and drained by the condensate drainage elbow (see § "1.2 I Hydraulic connections"). • To check that the water is not coming from a leak in the pool circuit on the heat pump, shut down the heat pump and run the filter pump to circulate water in the heat pump. If the water continues to flow through the condensate drainage lines, there is a water leak in the heat pump: contact your retailer.
The evaporator is iced over	<ul style="list-style-type: none"> • Your heat pump will soon switch to its defrost cycle to melt the ice. • If your heat pump cannot manage to defrost its evaporator, it will stop itself; this means that the outdoor temperature is lower than the minimum operating temperature.
The appliance is "smoking"	<ul style="list-style-type: none"> • The machine has come to the end of the defrost cycle; water has changed to gaseous state and passes through the grid. • If your heat pump is not in its defrost cycle, this is not normal. Switch off and disconnect the heat pump immediately and contact your retailer.
The appliance is not working	<ul style="list-style-type: none"> • If there is no display, check the power voltage and the fuses. • When the setpoint temperature is reached, the heat pump stops heating: the water temperature is higher than or equal to the setpoint temperature. • When the water flow rate is zero or is not enough, the heat pump stops: check that the water is circulating correctly in the heat pump (see § "2.2 I User interface presentation"). • The outdoor temperature is outside the heat pump's operating range. • It may be that the heat pump has detected an operating fault (see § "4.2 I Error code display").
The appliance is working but the water temperature does not increase	<ul style="list-style-type: none"> • Check that the automatic water filling controller (see diagram in § "2.3 I Operation") is not stuck in the open position: this will keep supplying cold water into the pool and will prevent the temperature from rising. • There is too much heat loss: install a heat insulated cover on your pool. • The heat pump is unable to capture enough calories as its evaporator is clogged with dirt: clean it to restore its efficiency (see § "3.2 I Maintenance"). • Check that the external environment is not hindering the heat pump (see § "1 Installation"). • Check that the heat pump is the right size for this pool and its environment.
The fan is running but the compressor stops from time to time with no error message	<ul style="list-style-type: none"> • If the outdoor temperature is low, the heat pump performs defrost cycles under normal operation. • The heat pump is unable to capture enough calories as its evaporator is clogged with dirt. Clean it to restore its performances (see § "3.2 I Maintenance").
The appliance trips the circuit breaker	<ul style="list-style-type: none"> • Check that the circuit breaker is correctly dimensioned and that the cable section used is appropriate (see § "5.2 I Technical specifications"). • The supply voltage is too low: contact your electricity supplier.

4.2 I Error code display

Display	Possible causes	Solutions
PP01 <i>Faulty inlet water temperature sensor</i>	Sensor disconnected or out of order.	 Reconnect or replace the sensor.
PP02 <i>Faulty outlet water temperature sensor</i>	Sensor disconnected or out of order.	 Reconnect or replace the sensor.
PP03 <i>Faulty coil temperature sensor</i>	Sensor disconnected or out of order.	 Reconnect or replace the sensor.
PP04 <i>Faulty discharge gas temperature sensor</i>	Sensor disconnected or out of order.	 Reconnect or replace the sensor.
PP05 <i>Faulty ambient temperature sensor</i>	Sensor disconnected or out of order.	 Reconnect or replace the sensor.
PP06 <i>Faulty cooling condenser sensor</i>	Sensor disconnected or out of order.	 Reconnect or replace the sensor.
PP07 <i>Winter frost protection</i>	Ambient temperature or input water temperature too low.	 Check D3 and D1.
PP08 <i>Ambient temperature protection too low</i>	The ambient temperature is too low.	 Check D3.
	Sensor disconnected or out of order.	 Reconnect or replace the sensor.
PP10 <i>Condenser cooling temperature too high protection</i>	Ambient temperature too high	Check the temperature.
	Refrigerant problem	 Check the refrigerant.
PP11 <i>Water temperature too cold protection in cooling mode</i>	Water flow too low	Check the water flow rate and by-pass.
	Abnormal temperature of d2-TH5 sensor	 Check the refrigerant and d2-TH5 sensor.
EE01 <i>High pressure protection</i>	Ambient temperature too high.	Check the water flow rate and by-pass.
	Water temperature too high.	 Check the fan.
	Check the fan speed.	 Check the refrigerant.
EE02 <i>Low pressure protection</i>	Low-pressure sensor broken.	 Replace the high-pressure sensor.
	Insufficient level of refrigerant.	 Add refrigerant.
	Ambient temperature and input water temperature too low.	Send the pump to the retailer for a detailed inspection.
EE03 <i>Water flow rate protection</i>	Flow switch incorrectly positioned.	 Re-make the connections.
	Insufficient water flow.	Increase the water flow rate.
	Broken flow switch.	 Replace the flow switch.
	Faulty filter pump.	Repair or replace the filter pump.

EE04 <i>In heating mode, temperature overheating error</i>	In heating mode, temperature overheating error.	Check that the flow rate is sufficient.
	Faulty flow switch.	 Replace the flow switch.
	Abnormal d2-TH5 sensor reading.	 Replace the d2-TH5 sensor.
EE05 <i>d6-TH3 exhaust temperature protection</i>	Insufficient refrigerant.	 Check for the presence of gas leaks and add refrigerant.
	Insufficient water flow rate.	Check the by-pass valve.
	Clogged filter or electronic valve.	 Check refrigerant levels.
	d6-TH3 sensor fault.	 Check the d6-TH3 sensor.
EE06 <i>Controller fault</i>	The connection is faulty.	 Check the connection.  Replace the cable.
	The controller is faulty.	 Replace the controller.
EE07 <i>Compressor protection</i>	The connection is faulty.	 Check the connection.
	Accumulation of liquid and gas.	 Check the power supply voltages
	Faulty compressor or printed circuit board.	 Check the phases.
	Abnormal water flow rate.	 Check the water flow rate.
	Fluctuating power supply.	Check the electrical grid.
EE08 <i>Communication error between the controller and the power board</i>	The connection is faulty.	 Check the connection.  Replace the cable.
	The controller is faulty.	 Replace the controller.
EE09 <i>Communication error between the controller and the control board.</i>	The connection is faulty.	 Check the connection.  Replace the cable.
	The controller is faulty.	 Replace the controller.
EE10 <i>High voltage protection</i>	Voltage too high.	 Check the voltage.
	Faulty power board.	 Replace the power board and/or control board.
EE11 <i>Faulty motherboard for IPM module</i>	The data is incorrect.	Programming error, disconnect the power supply and start after 3 minutes.
	The connection is faulty.	 Check the connection.
	Accumulation of liquid and gas.	 Check the power supply voltages
	Faulty compressor or printed circuit board.	 Check the phases.
EE12 <i>The power supply is too low</i>	The power supply is incorrect.	 Check the power supply voltage.
	The power board is faulty.	 Replace the board.

EE13 <i>Electrical protection</i>	The data is incorrect.	 Check the compressor.
	The water flow rate is insufficient.	Check the water flow rate.
	The voltage is unstable.	 Check the power supply voltages.
	PFC failure.	
EE14 <i>Abnormal IPM module operating temperature</i>	The power supply is incorrect.	 Check the power board.
	The fan motor is defective or the propellers are broken.	Check the fan speed Check the propellers.
EE15 <i>IPM module high temperature protection</i>	The power supply is incorrect.	 Check the printed circuit board.
	The fan motor is defective or the propellers are broken.	Check the fan speed Check the propellers.
EE16 <i>PFC module protection</i>	The data is incorrect.	 Check the printed circuit board.
	The fan motor is faulty.	Check the fan speed.
	The propellers are broken.	Check the propellers.
	The voltage is unstable.	 Check the voltage.
EE17 <i>DC fan error</i>	The fan motor is faulty.	 Check the fan motor.
	The printed circuit board is faulty.	 Replace the printed circuit board.
	The propellers are faulty.	Check the propellers.
EE18 <i>Abnormal PFC module operating temperature</i>	The printed circuit board is faulty.	 Replace the printed circuit board. Check the fan speed. Check the propellers.
EE19 <i>PFC module high temperature protection</i>	The power supply is incorrect.	 Check the printed circuit board
	The fan motor is faulty.	Check the fan speed.
	The propellers are broken.	Check the propellers.
	The connections to the power board are loose.	 Check the connections, tighten the screws.
EE20 <i>Power supply error</i>	The power supply varies too much.	 Check the power supply voltage.
EE21 <i>Programme error.</i>	The compressor is losing power, operating at an irregular speed.	 Check the printed circuit board  Reload the programme
	Programme error.	
	Impurity in the compressor.	
EE22 <i>High voltage protection</i>	The power supply is incorrect.	 Replace the printed circuit board.
	The power board is faulty.	 Replace the printed circuit board.
EE23 <i>Compressor start-up error</i>	The power board is faulty.	Check the printed circuit board.
	Accumulation of liquid and gas.	 Check the power supply voltages
	The voltage is unstable.	 Check the voltage.

EE24 <i>Ambient temperature or printed circuit board</i>	Ambient temperature or input water temperature too low.	 Check and replace the printed circuit board.
EE25 <i>Compressor power error</i>	The compressor operates with 1 or 2 phases.	 Check the wiring.
EE26 <i>4-way valve inversion error</i>	Blockage-inversion of the 4-way valve.	Switch to heating/cooling mode to check inversion of the valve.  Replace the 4-way valve.
	Low refrigerant (no d5-TH2 or d3-TH1 detection).	 Check refrigerant levels.
EE27 <i>EEPROM memory data error</i>	Data loss in the memory.	 Reload the data to the memory.
	Printed circuit board error.	 Replace the printed circuit board.
EE28 <i>Communication error with the controller</i>	Printed circuit board error.	Off/on to restart.  Check and replace the printed circuit board.

4.3 I Wiring diagrams 25

4.3.1 PX50 MD3 - MD4 - MD5 - MD6 - MD7

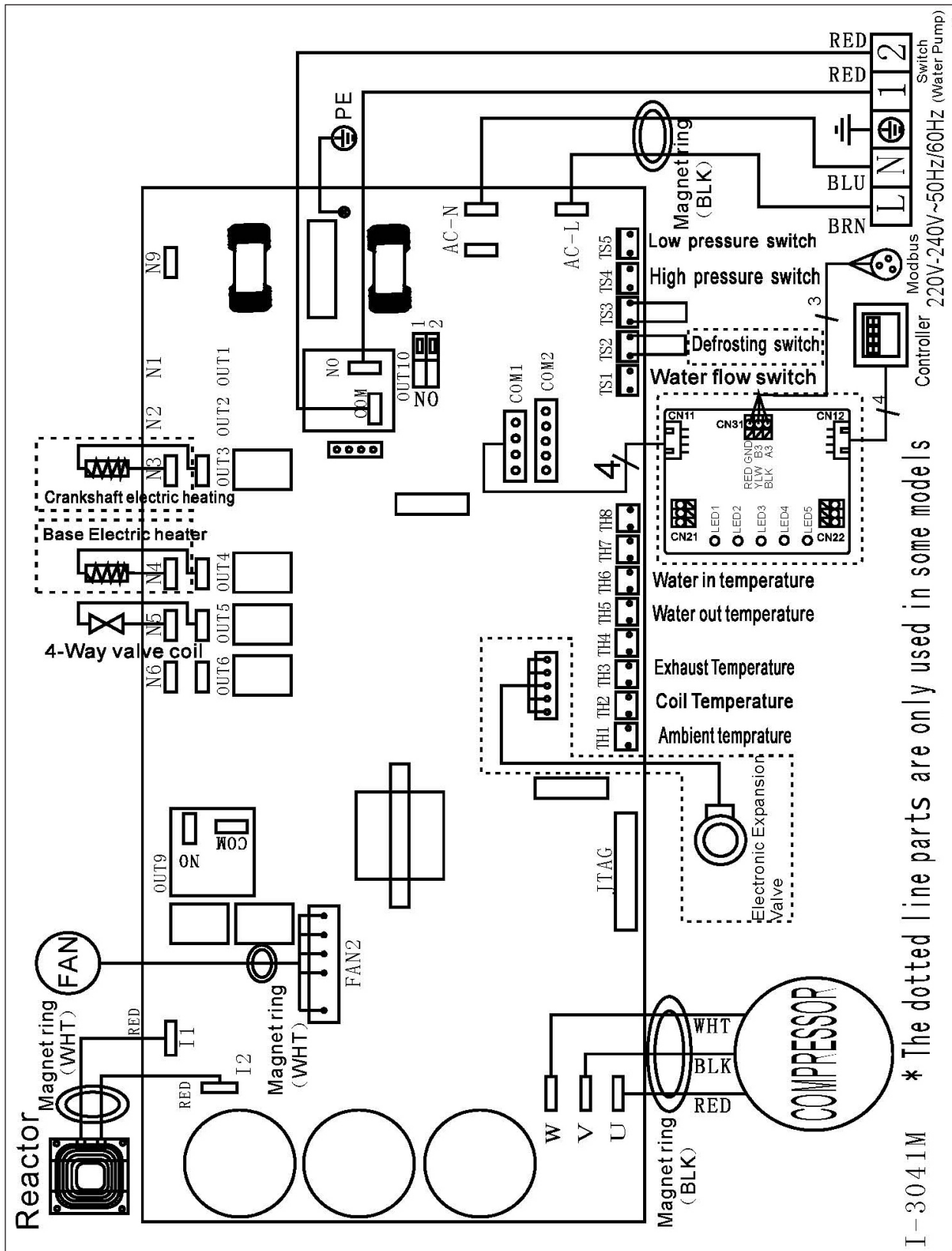

EN

4.3.2 PX50 MD9

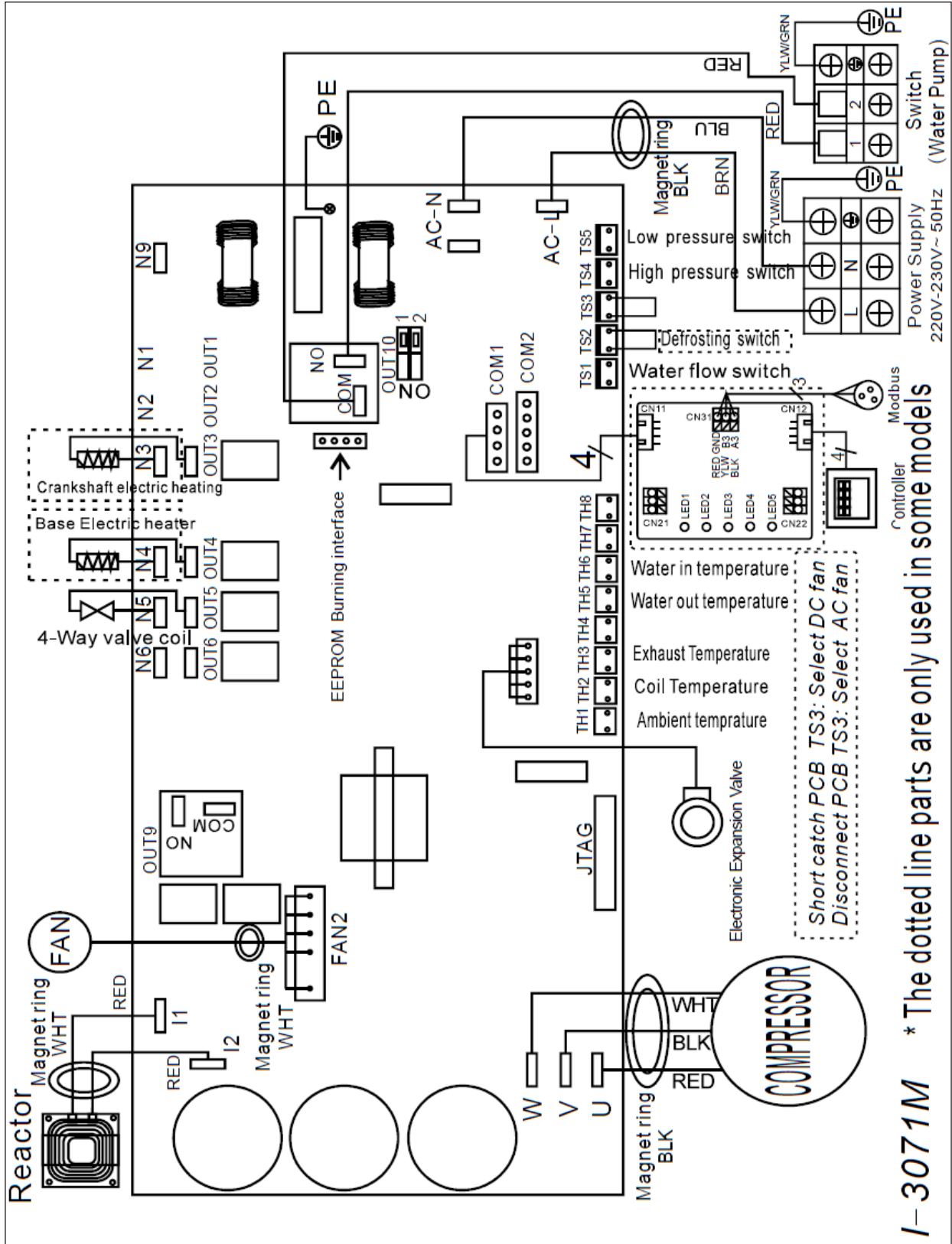

4.3.3 PX50 MD11 - MD12

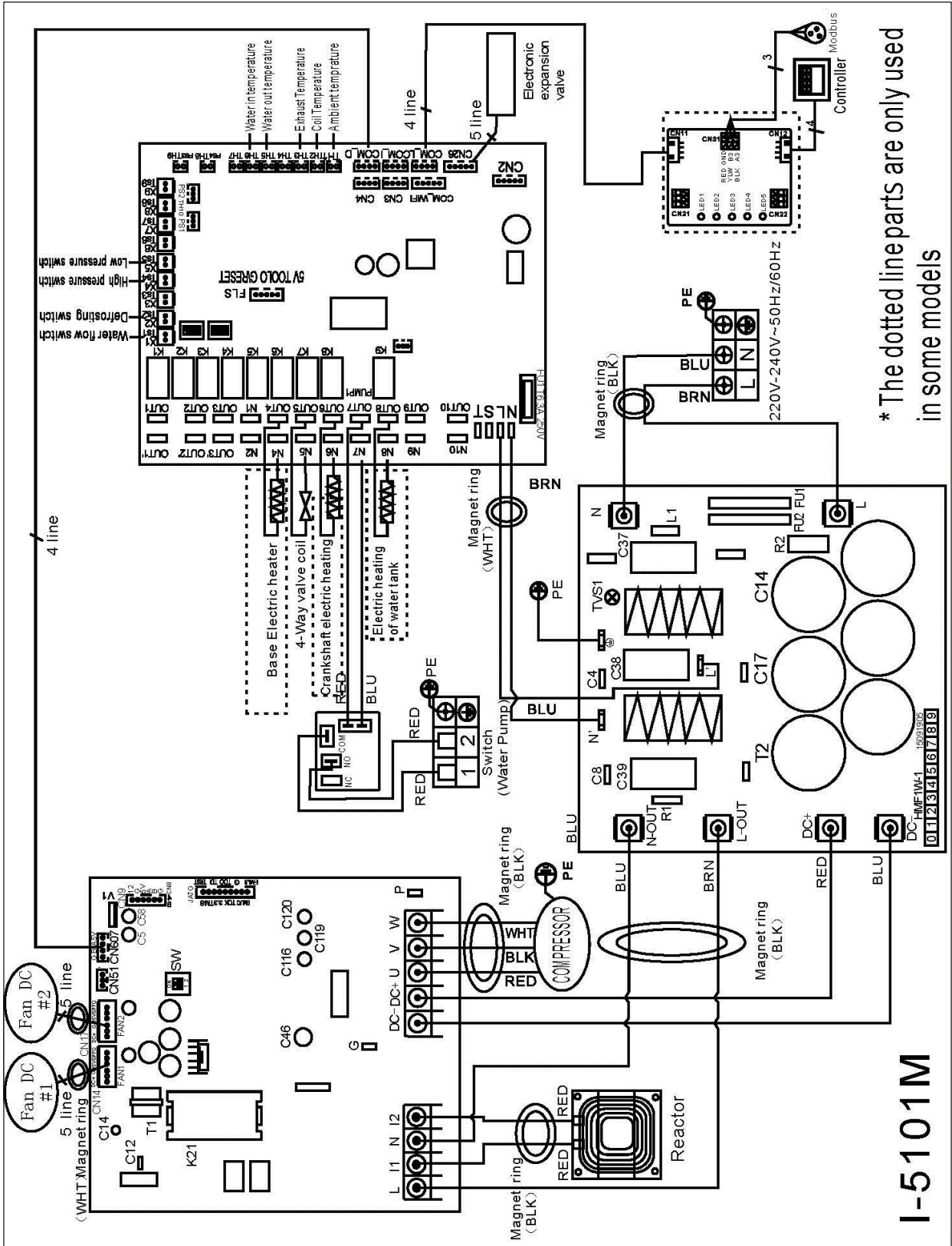

EN

4.3.4 PX50 TD11 - TD12

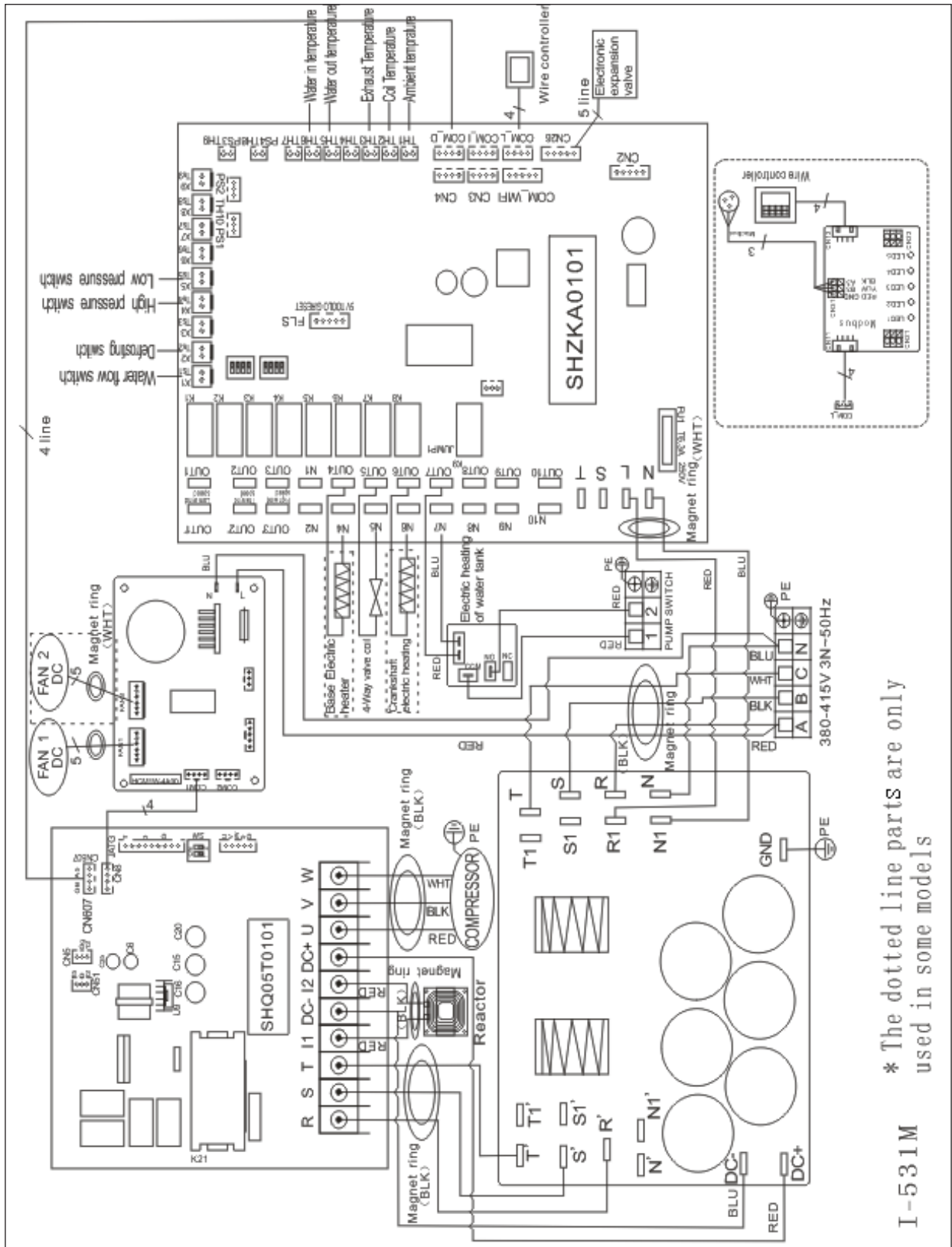



5 Specifications

5.1 I Description



A		PX50
B	Ø50 PVC connectors x2	✓
C	Anti-vibration pads x4	✓
D	Winterising cover	✓
	Heating priority	✓
E	Remote control kit	✓
F	Condensate drainage connector x2	✓
G	Hose x2	✓
H	PAC NET (cleaning product)	+

✓: Included

+: Available as an accessory

EN

5.2 I Technical specifications

PX50		MD3	MD4	MD5	MD6	MD7	MD9	MD11	TD11	MD12	TD12
Operating temperatures	air	Heating: from -12°C to 43°C/Cooling: from 15°C to 43°C									
	water	Heating: from 6°C to 41°C/Cooling: from 6°C to 35°C									
Power output (max-min speed)*	kW	9 - 1.9	10.5 - 2.1	13.5 - 2.5	16.5 - 5.3	19.5 - 3.5	25 - 4.5	31 - 5.6		35 - 7.6	
Voltage		220V-240V/1/50Hz						380V-415V /3/50 Hz	220V-240V /3/50Hz	380V-415V /3/50 Hz	
Admissible variation in voltage		± 10 %									
Pollution class**		I									
Pollution degree**		2									
Overvoltage category**		II									
Nominal current input	A	4.6	5.9	7.2	9.2	10.5	13.2	17	7	23.16	8.4
Maximum electric current requirement	A	6.34	7.63	9.18	10.78	13.33	16.59	18.9	8.2	23.16	8.4
Minimum cable size**	mm ²	3 x 1.5		3 x 2.5			3 x 4		5 x 2.5	3 x 6	5 x 4
		3G1.5		3G2.5			3G4		5G2.5	3G6	5G4
Max Discharge/Suction pressure	bar	45									
Max High pressure/Low pressure side	bar	25									
Average water flow rate	m ³ /h	2.9	3.4	4	4.8	6	7.4	9.8	8	10.3	10
Sound pressure at 10 m	db(A)	31	32		33		35	39		50	68
Refrigerant type		R32						R410A	R32	R410A	
Refrigerant load	kg	0.72	0.55	0.8	0.81	1.5	1.7	2.4	3	2.4	4
CO ₂ equivalent	T	0.49	0.37	0.54	0.55	1.01	1.15	1.62	6.26	1.62	8.35
Approximate weight	kg	52	58	61	62	89	92	120	123	126	128

Appliance must have a protection rating (IP) IPX4 or above. Please read the label showing the protection rating IP for your product.

* Performance levels: air at 28 °C/water at 28 °C/humidity at 80%.

** These specifications have been determined based on the requirements defined in standards IEC/EN 60335-1 and IEC/EN 60035-2-40 on the safety of electrical appliances for household and similar purposes.

*** Values provided for information purposes for a maximum length of 20 metres (calculation base: NFC 15-100), must be checked and adapted to the installation conditions and standards of the installation country.

5.3 I Dimensions and marking

MD3 - MD4 - MD5 - MD6 - MD7 - MD9				MD11 - MD12 - TD11 - TD12							
Front											
								<p>K: Grid L: User interface M: Pool water inlet N: Pool water outlet O: Evaporator</p>			
Side											
Top											
Model	A*	B*	C*	D*	E*	F*	G*	H*	I*	J*	
MD3	858	25	626	97	348	90	334	371	270	293	
MD4 - MD5 - MD6	985	25	736	107	440	110	350	390	321	349	
MD7 - MD9	1073	25	927	107	600	111	399	440	442	374	
MD11 - MD12 - TD11 - TD12	1038.5	30	1384	112	850	118.5	389	429	325.5	339.5	

* Dimensions in mm.

Votre revendeur
Your retailer

Modèle appareil
Appliance model

Numéro de série
Serial number

Pour plus d'informations, enregistrement produit et support client :
For more information, product registration and customer support:

www.zodiac.com

